

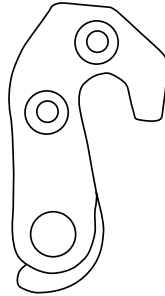

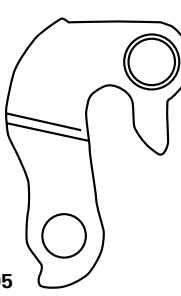

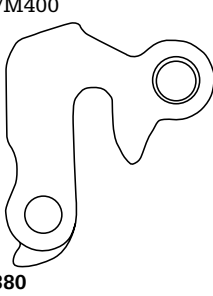
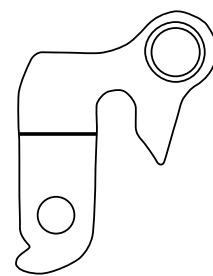

Replaceable Derailleur Hanger Identifier

RALEIGH DIAMONDBACK UNIVEGA
NISHIKI AVENIR CYCLEPRO

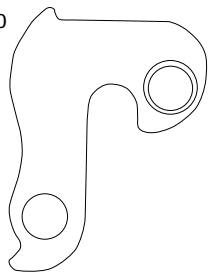
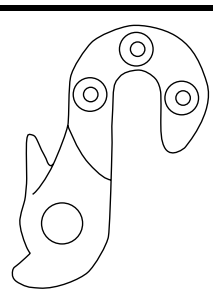
Raleigh	<p>1996: M600, M800 1997: M600, M800</p>  <p>DP# 32-00-200 OEM# 001-2204</p>	<p>1996: MCC 7 & 8</p>  <p>DP# 32-00-210 OEM# 001-2205</p>	<p>1998: M7000/8000/7500/M400 1999: M600/800</p> <p>{ From Kenesis serial number from frame manufacturer begins with a "K" }</p>  <p>DP# 32-00-230 OEM# 001-2380</p>
	<p>1998: M80, F500 1999: M40, M45, M55, M60, M80, F500 2000: M45, M60, Derby Police</p>  <p>DP# 32-00-240 OEM# 001-2394</p>	<p>1998-1999: R500, R600, R700, R500, R600, R700</p> <p>2000: R500, R600, R700 2001: R500, R600, R700</p>  <p>DP# 32-00-260 OEM# 001-2412</p> <p>DP# 32-00-262 OEM# 001-3110</p>	<p>1998: M400, M600, M800</p> <p>{ From A-Pro serial number from frame manufacturer begins with an "A" }</p>  <p>DP# 32-00-270 OEM# 001-2444</p>
	<p>1997: M400</p>  <p>DP# 32-00-280 OEM# 001-2252</p>	<p>1999: M7000, M8000 2000: M7000, M8000</p>  <p>DP# 32-00-290 OEM# 001-2560</p>	<p>2000: R800</p>  <p>DP# 32-00-300 OEM# 001-2879</p>
	<p>2000: M80, M600, M800 2001: C500, M800, M600, M80, M60, M50, M40</p> <p>Also: M8000, M7000 { in black }</p>  <p>DP# 32-00-310 OEM# 001-2699</p>	<p>2000: C400</p>  <p>DP# 32-00-250 OEM# 001-2377 { same as H-195 001-2880 }</p>	<p>Nishiki 1997 Carcade</p>  <p>DP# 32-00-280 OEM# 001-2252</p>
Nishiki	<p>1999: Cascade</p>  <p>DP# 32-00-230 OEM# 001-2380</p>	<p>1998: Back Roads, Colorado 1999: Back Roads, Colorado</p>  <p>DP# 32-00-240 OEM# 001-2394</p>	<p>1998 Cascade, Pinnacle</p>  <p>DP# 32-00-270 OEM# 001-2444</p>

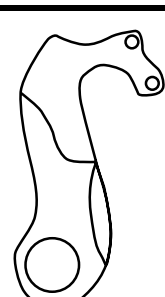
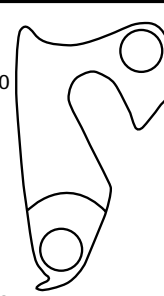
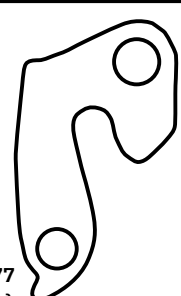
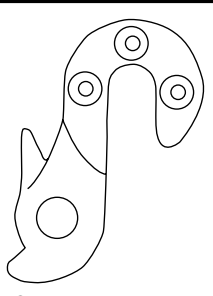
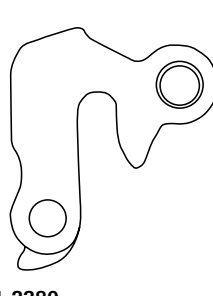
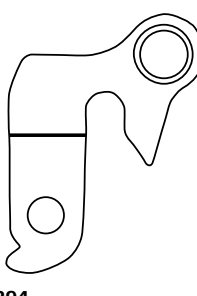
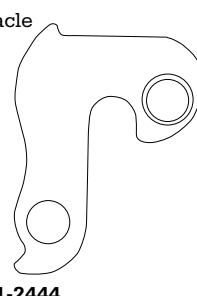

RALEIGH DIAMONDBACK UNIVEGA
NISHIKI AVENIR CYCLEPRO

Replaceable Derailleur Hanger Identifier

Diamondback

2000: Master, Expert



DP# **32-00-260** OEM# **001-2412**

1995: Vertex
1996: V-Link Pro, V-Link 3.0, Zetec, Zetec Pro

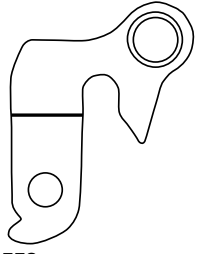

DP# **32-96-100** OEM# **001-2552**
001-2444

2001: Podium, Reactor Dual



DP# **32-00-310** OEM# **001-2699**

1997: Lakeside, Response, V-links (Pro, 1.1, 3.1), Zetec (Pro, 2.1, 4.1)
1998: Lakeside, Voyager (1, 2, 3), V-link 1.2, V-6, V-10, V-Link 1.2, Zetec Comp, Team Issue
1999: Expert, Response, SE, Sherwood, Team Issue, Topanga SE, Voyager, 2 & 3, X Series, XR Series, Zetec Comp.
2000: Crestview, Expert, Oakpoint, Master, Response, Response Sport, Sherwood, Topanga, Topanga Comp, X-Link, X-2, X-6, XR-1, XR-8
2001: XTS Series, Topanga Comp., Topanga, Response, Sorento Sport, Oak Point

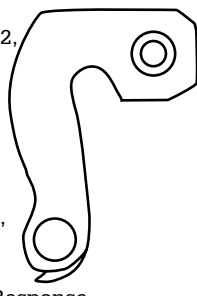

DP# **32-90-250** OEM# **001-2691**

2000: Apex, Zetec Comp
2001: Apex

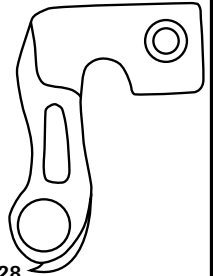

DP# **32-90-252** OEM# **001-2828**

1996-1999: Europe Road Bikes, Podium 2.1



DP# **32-97-100**

Univega

1996: Podium 1.0, 2.0

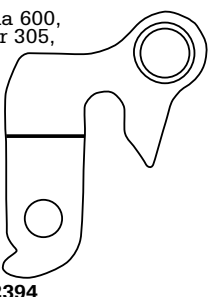

DP# **32-96-110**

1995: Dual Action Comp, Team, Pro
1996: AL700 Series, Dual Action Comp, Pro, Team
1997: Dual Action Comp, Team, Pro, Via de Oro, Zig Zag STX
1998: DS900, DS950

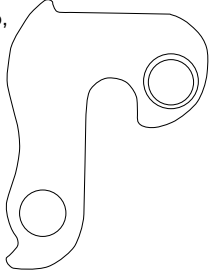

Univega

1998: FS 700, FS 750, Zig Zag, Zig Zag(+)
Same as { 001-2880 }

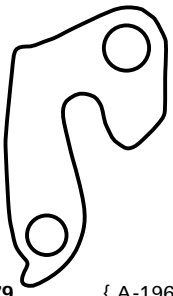

DP# **32-00-250** OEM# **001-2379** { A-196 }

1999: Alpina 500, Alpina 600, Alpina 700, Rover 305, Rover 308
2000: Rover 303, Rover 305, Rover 308
2000: Alpina 500, Alpina 600, Alpina 700

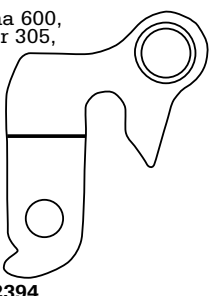

DP# **32-00-240** OEM# **001-2394**

1999: Alpina 500, Alpina 600, Alpina 700
1999: DS 900, DS 950

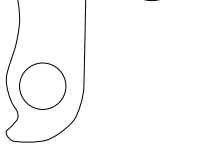

DP# **32-00-270** OEM# **001-2444**
DP# **001-2444** OEM# **001-2552**

2001 Alpina 400,500, DS 700



DP# **32-00-310** OEM# **001-2699**

2001: DS 900



DP# **32-00-290** OEM# **001-2560**

2000: DS 700, DS 900, DS 950

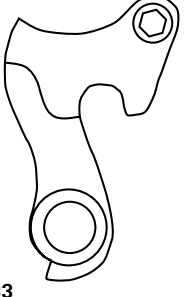

DP# **32-00-302** OEM# **001-2833**